

803.030.0.00.03.050

Leonardo 803 H 3x

3x50W | 230V/12V | QR111 | G53 |
3x100W | 230V | QPAR111 | GZ10 |



Dane produktu: Product data:

Materiał: aluminium Material: aluminum

Dostępne kolory: Available colors:

- **satyna** satin

Montaż: nastropowo (zwieszana) Montage: ceiling-mounted (hanging)

Zasilanie: 230V/12 lub 230V Power supply: 230V/12 or 230V

Źródło światła: Lightsource:

- QR111 (3x50W) QR111 (3x50W)
- QPAR111 (3x100W) QPAR111 (3x100W)

Rodzaj trzonka: G53 / GZ10 Kind of spot: G53 / GZ10

IP: 20 IP: 20

Waga: 2 kg weight: 2 kg

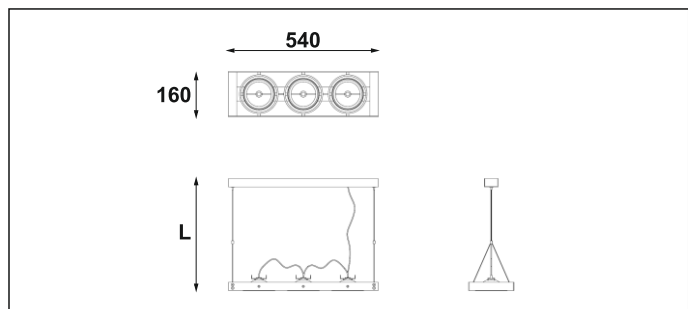

Długość linki (L):
The length of the rope (L):
maksymalnie 2500mm*
up to 2500mm*

*możliwa dowolna długość na zamówienie
*can be any length to order

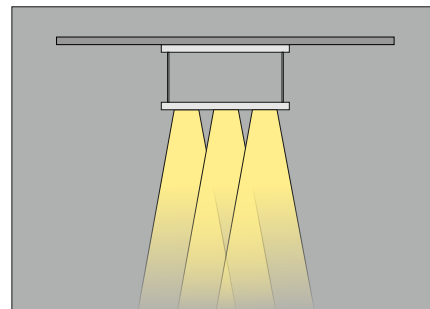

Nr			W	V	kg		
803.030.0.00.03.050 803.130.0.00.03.100	nastropowa nastropowa	QR111 [G53] QPAR111 [GZ10]	3x50W 3x100W	230V/12V 230V	2,0 kg 2,0 kg	540x160 540x160	satyna satyna