

823.010.0.00.03.100

Leonardo 823 L 3x

3x100W | 230V/12V | QR111 | G53 |
3x100W | 230V | QPAR111 | GZ10 |
3x35W | 230V | CDMR111 | GX8,5 |



Dane produktu: Product data:

Materiał: aluminium Material: aluminum

Dostępne kolory: Available colors:

- **satyna** satin

Montaż: nastropowo Montage: ceiling-mounted

Zasilanie: 230V/12 lub 230V Power supply: 230V/12 or 230V

Źródło światła: Lightsource:

- **QR111 (3x100W)** QR111 (3x100W)
- **QPAR111 (3x100W)** QPAR111 (3x100W)
- **CDMR111 (3x35W)** CDMR111 (3x35W)

Rodzaj trzonka: G53 / Gz10 / GX8.5 Kind of spot: G53 / GZ10 / GX 8.5

IP: 20 IP: 20

Waga: 3.5 kg weight: 3.5 kg

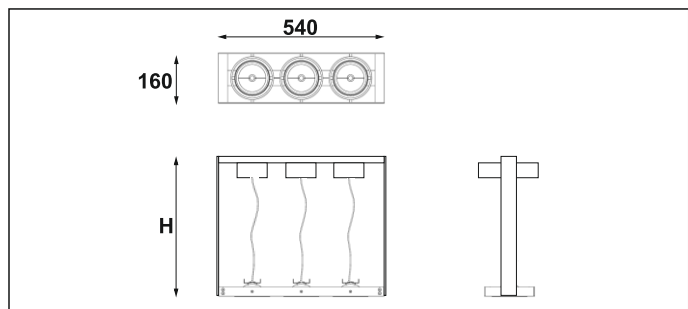

Długość linki (H):

The length of the rope (H):

Od 200mm do 1000mm*

From 200mm to 1000mm *

*możliwa dowolna długość na zamówienie
*can be any length to order

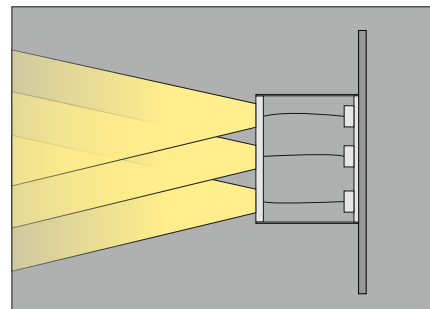

Nr			W	V	kg	mm	
823.010.0.00.03.100	nastropowa	QR111 [G53]	3x100W	230V/12V	3,5 kg	540x160	satyna
823.110.0.00.03.100	nastropowa	QPAR111 [GZ10]	3x100W	230V	3,5 kg	540x160	satyna
823.310.0.00.03.035	nastropowa	CDMR111 [GX8,5]	3x35W	230V	3,5 kg	540x160	satyna